

FALCON LIFTS A/S

Tolderlundsvej 106
DK-5000 Odense C
Tel: +45 66 13 11 00

falconlifts.com



FALCON 420

Double Track

Reach diagram - Optimized position

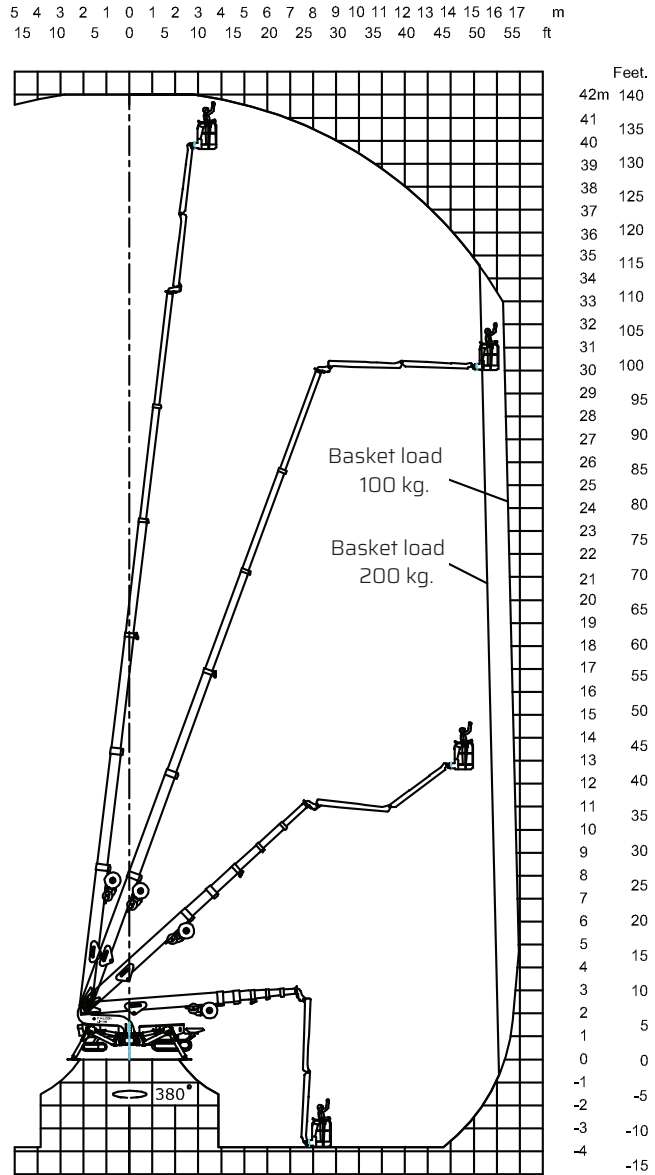
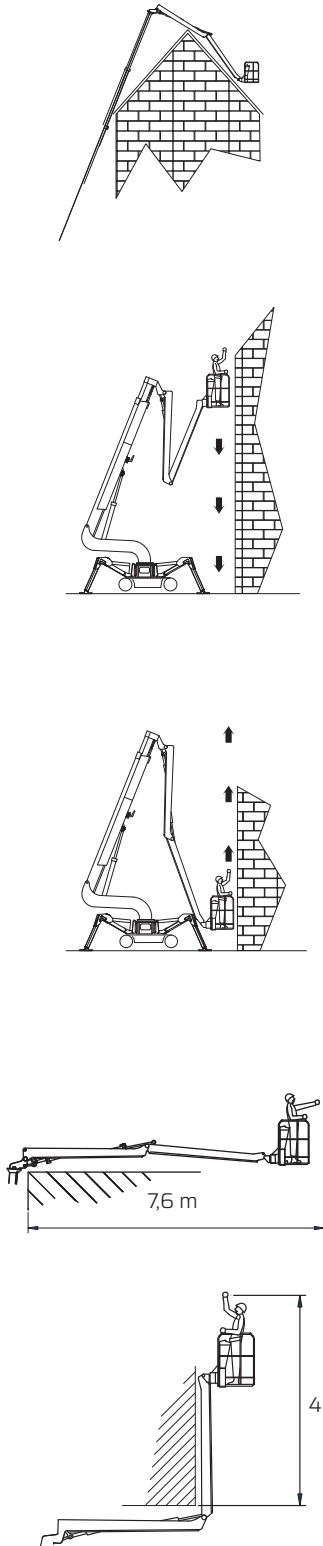

Reach with outriggers in different positions

Standard

Measurements in meters

Optimized

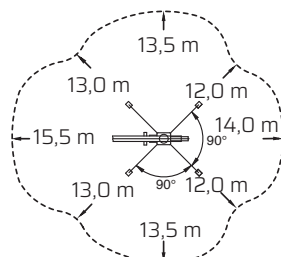

Basket load = 200 kg

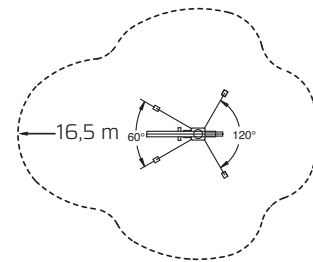

Basket load = 100 kg

All measurements are intended as guide. Choise of equipment may change the mentioned measurements

FALCON 420

Double Track

Outer measurements

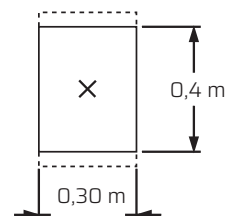
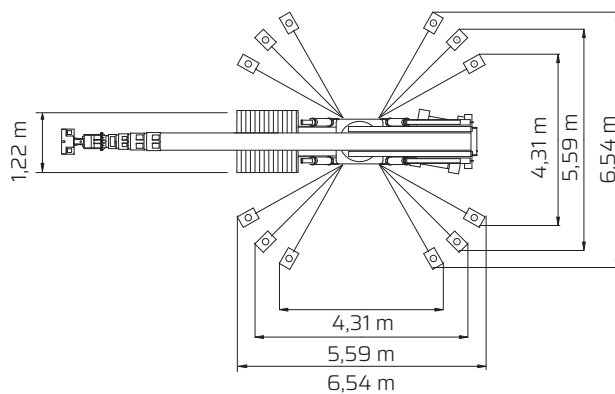
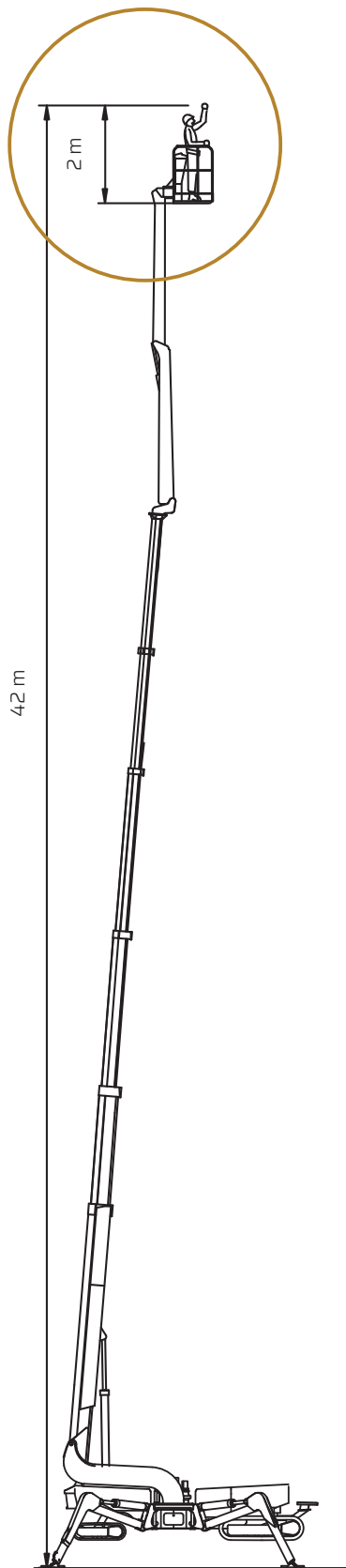

Outrigger plate area = 1200 cm²

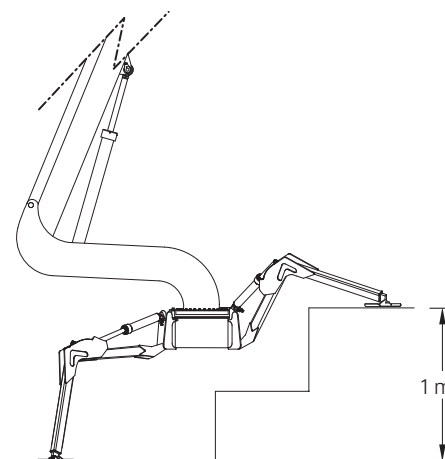
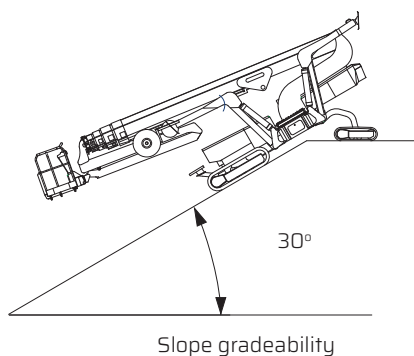
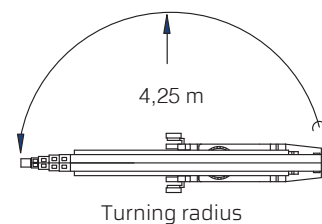
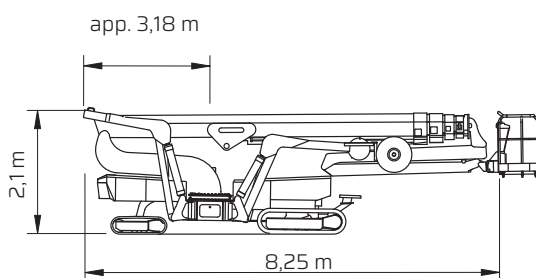

Additional info:

Weight and ground pressure:

Weight with standard equipment	8200	kg.
Surface pressure under crawlers (soft surface)	0,80	kg/cm ²
Surface pressure under crawlers (hard surface)	1,65	kg/cm ²
Max. ground pressure under 1 outrigger plate	3,10	kg/cm ²